

### Features & Benefits

#### ☞ Superior Technology Solutions

- Brightest Output
- CERTIFIED Burn Time Performance
- Longest life
- Smart Controller

#### ☞ Smart Technology (Optional)

- Automatic Light & Time Control
- Infrared Human Sensor (PIR)
- Microwave Sensor
- Web based control/monitoring available



Exclusive Free  
Battery Recycling  
Program



Available with:



5G Remote Access

- Monitor
- Set Timing
- Get Alerts

### Certifications



LISTED  
Components

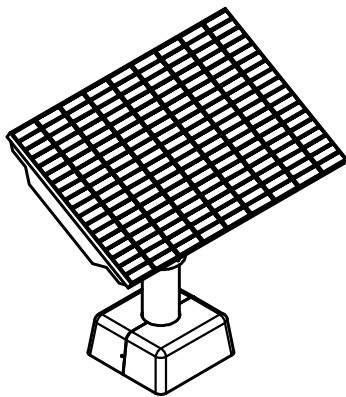

41.13 40W  
32.25 20W

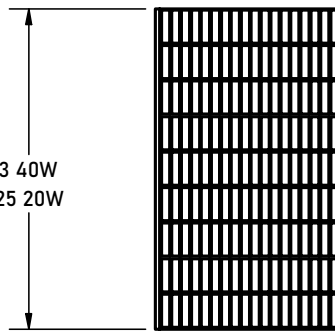

26.75 (40W)  
19.50 (20W)

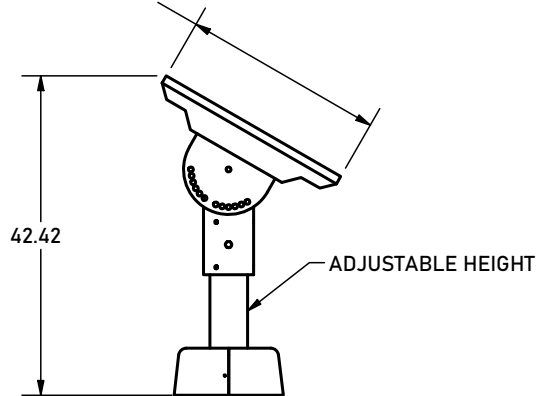

OTHER MOUNTING OPTIONS  
AVAILABLE SUCH AS  
RETROFITTING  
ON EXISTING POLES.

CUSTOM CAGES  
AVAILABLE FOR SHORT  
POLE MOUNT  
INSTALLATIONS

Model	Watts	Solar Panel	Battery
Cuesta Sol CS-PRE-TOR	20W	18V/70W	691.2WH / 12.8V / 54AH
Cuesta Sol CS-PRE-TOR	40W	18V/130W	1382.4 WH / 12.8V / 102AH



AMERICAN COMBAT VETERAN OWNED COMPANY



405-673-8684  
[www.gridshiftsolar.lighting](http://www.gridshiftsolar.lighting)



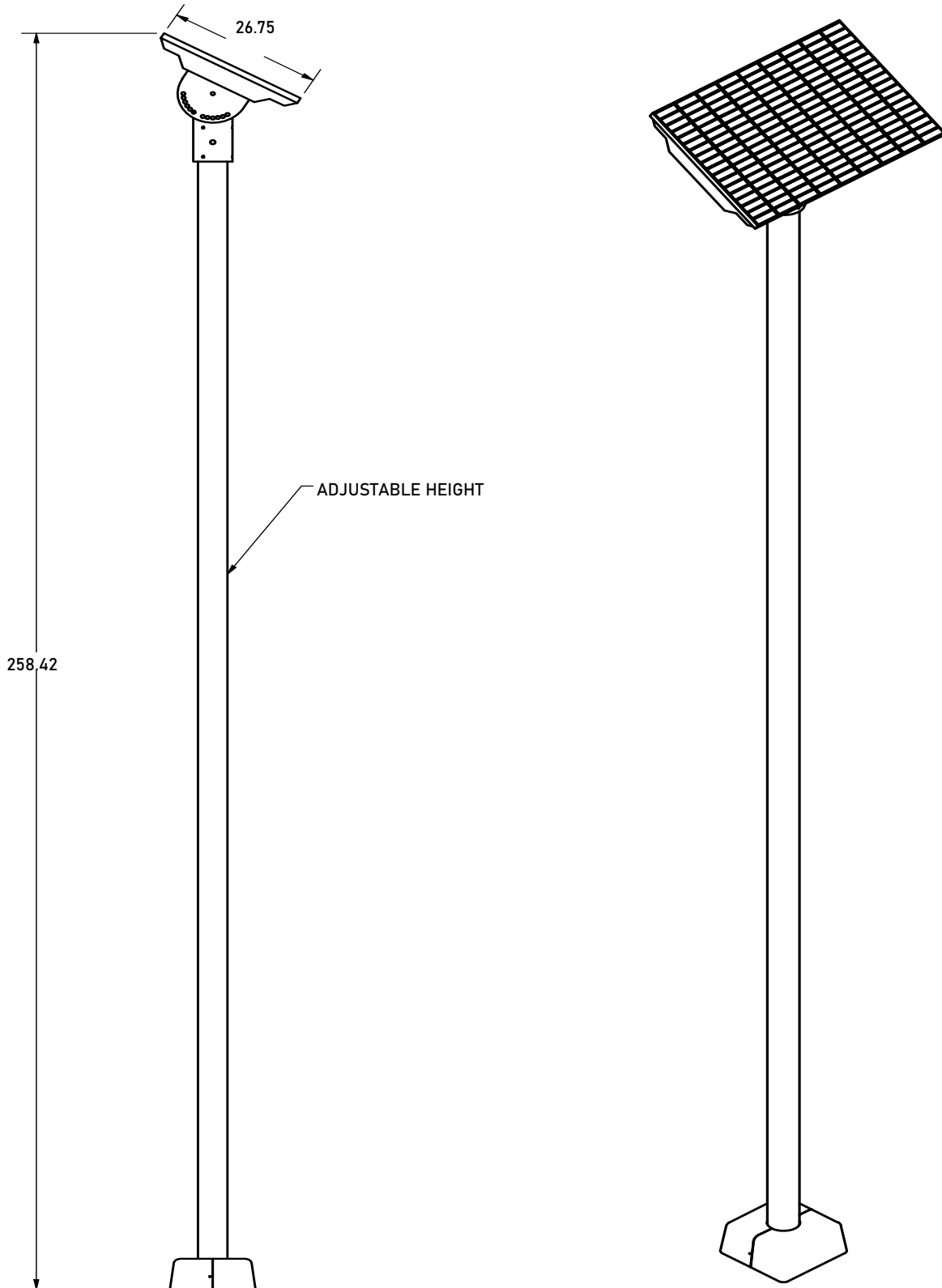

AMERICAN COMBAT VETERAN OWNED COMPANY



405-673-8684  
[www.gridshiftsolar.lighting](http://www.gridshiftsolar.lighting)





Cuesta Sol™

TORRENT SOLAR 12V PRO SOLAR SIGN LIGHT

CS-PRE-TOR-(20W-40W)

**8W Sign Light Specifications**

**CONSTRUCTION:** Extruded aluminum floodlight with cast aluminum adjustable swivel. Heavy-duty stamped aluminum Hood Extension available (add -HE to part number)

**LENS:** High impact clear acrylic

**REFLECTOR:** Highly polished specular aluminum

**LIGHT SOURCE:** 12v, 8w integrated LED flat panel, warm white 3000K, (630 lumens)

**LIFETIME RATING:** 50,000 hours

**SOCKET:** None

**12V INTERNAL DRIVER:** 8w output, 12v AC input. Voltage range of 9 to 18 volts with optimum operating range of 10 to 15 volts for consistent performance and brightness. For use with magnetic transformers only.

**WIRING 12v:** Black 3 foot 18/2 zip cord from base of fixture (12v only)  
For 25 foot 16/2 fixture lead wire add -25F to catalog number.

**MOUNTING 12v:** FA-03 black 9" ABS stake, tapped 1/2" NPS

**FINISH:** Black texture polyester powder coat. Optional finishes available

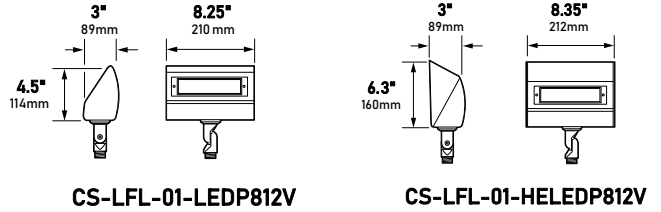

CS-LFL-01-LEDP812V

CS-LFL-01-HELEDP812V



IP44



**ORDERING INFORMATION**

CATALOG NO.	DESCRIPTION	LAMP	SHIP WEIGHT
CS-LFL-01-LEDP812VBTL	Aluminum Floodlight	8w, 3000K 12v LED Panel	2.0 lbs.
CS-LFL-01-HELEDP812VBTL	Aluminum Floodlight, hood extension	8w, 3000K 12v LED Panel	2.0 lbs.

**BEAM/GLARE CONTROL ACCESSORIES**

-HE Add to catalog number for Hood Extension

**MOUNTING ACCESSORIES**

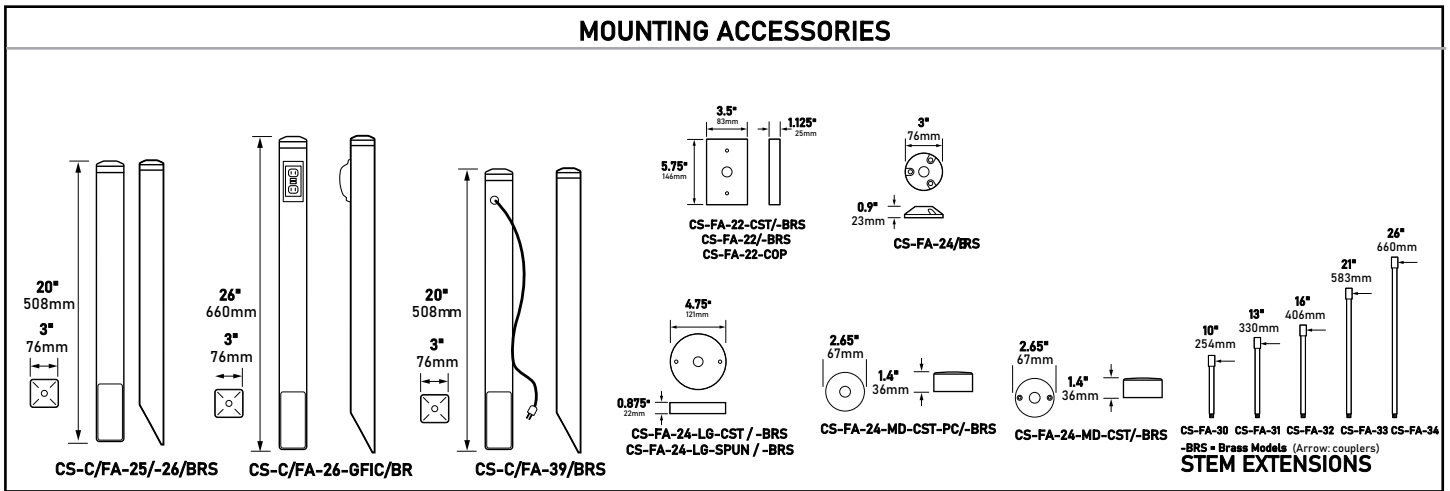

Black Texture (Standard)	Antique Verde	Bronze Texture	Camel	White Texture	Hunter Texture	Rust	Weathered Iron	Weathered Brown	Stucco	Rubbed Verde	Chrome Powder	Acid Rust	Acid Verde	Black Acid Treatment
-BLT	-ATV	-BRT	-CAM	-WTX	-HTX	-RST	-WIR	-WBR	-STU	-RBV	-CPR	-BAR/CAR	-BAV/CAV	-BAT

BRASS & COPPER ONLY



AMERICAN COMBAT VETERAN OWNED COMPANY



405-673-8684  
www.gridshiftsolar.lighting

**GRIDSHIFT™**  
SOLAR LIGHTING

Corporate: 2803 Broadway Ct. Edmond, OK 73013  
California: 1341 Distribution Way, Suite 20, Vista, CA 92081

Cuesta Sol is a trademark of GridShift Solutions, LLP



Wounded Warrior Project



# Cuesta Sol™

## TORRENT SOLAR 12V PRO SOLAR SIGN LIGHT CS-PRE-TOR-(20W-40W)

### LIGHT DISTRIBUTIONS AND PHOTOMETRICS

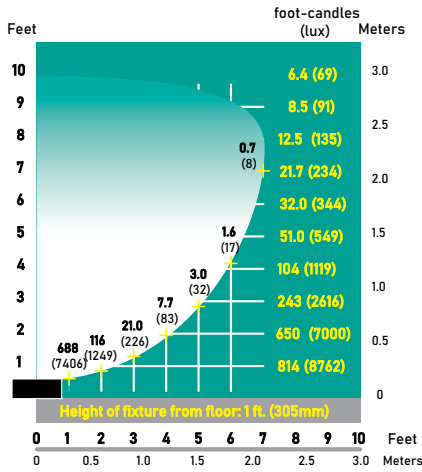

CS-LFL-01-LEDP8 Half Spread Photometrics

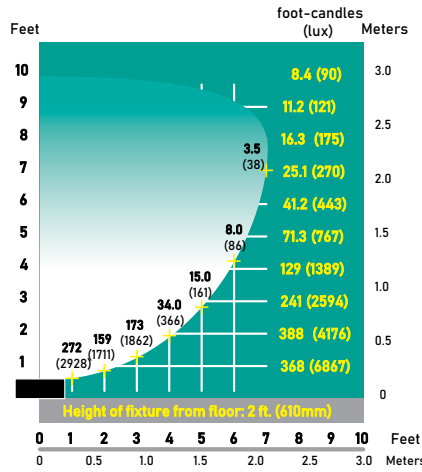

CS-LFL-01-LEDP8 Half Spread Photometrics

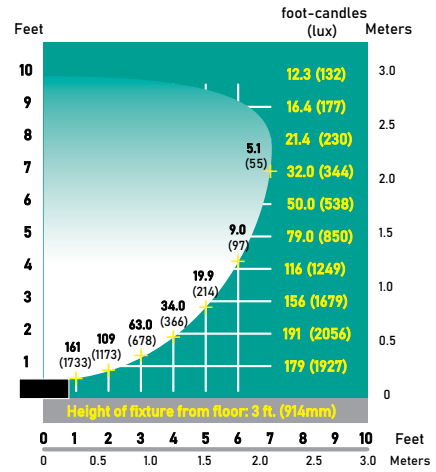

CS-LFL-01-LEDP8 Half Spread Photometrics

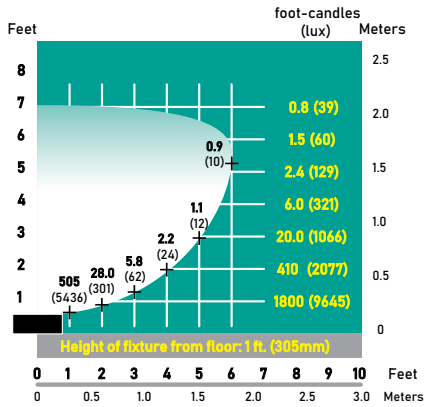

CS-LFL-01HE-LEDP8 Half Spread Photometrics

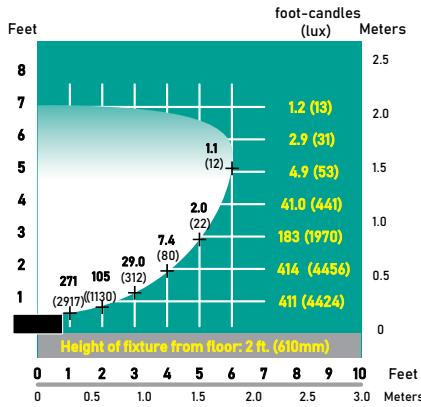

CS-LFL-01HE-LEDP8 Half Spread Photometrics

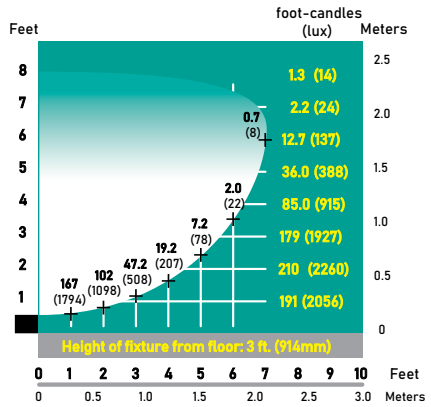

CS-LFL-01HE-LEDP8 Half Spread Photometrics



AMERICAN COMBAT VETERAN OWNED COMPANY



405-673-8684  
[www.gridshiftsolar.lighting](http://www.gridshiftsolar.lighting)

**GRIDSHIFT™**  
SOLAR LIGHTING

Corporate: 2803 Broadway Ct. Edmond, OK 73013  
California: 1341 Distribution Way, Suite 20, Vista, CA 92081

Cuesta Sol is a trademark of GridShift Solutions, LLP



Wounded Warrior Project

### 12W & 24W Sign Light Specifications

**CONSTRUCTION:** Extruded aluminum floodlight with cast aluminum adjustable swivel. Heavy-duty stamped aluminum Hood Extension available (add -HE to part number)

**LENS:** High impact clear acrylic

**REFLECTOR:** Highly polished specular aluminum

**LIGHT SOURCE:** Each LED Panel is: 12v, 12w, 1080 lumens integrated LED flat panel, warm white 3000K or 12v, 12w, 1160 lumens integrated LED flat panel, coolwhite 5200K (add -52 to part number)

**LIFETIME RATING:** 50,000 hours

**SOCKET:** None

**12V INTERNAL DRIVER:** 12w output, 12v AC input. Voltage range of 9 to 18 volts with optimum operating range of 10 to 15 volts for consistent performance and brightness. For use with magnetic transformers only.

**WIRING 12v:** Black 3 foot 18/2 z

**MOUNTING 12v:** CS-03LG black 9" ABS stake, tapped 1/2" NPS, Pole mounting available, custom mounting options available.



**24W**

**CS-LFL-LED24-12VBTL**

**1 LIGHT PER  
SOLAR PANEL**



**12W**

**CS-LFL-LED12-12VBTL**

**UP TO TWO LIGHTS  
PER PANEL**

### Light Ordering Information

CATALOG NO.	DESCRIPTION	LAMP	SHIP WEIGHT
CS-LFL-01-LED12-12VBTL	Aluminum Floodlight	12w, 3000K 12v LED Panel	2.0 lbs.
CS-LFL-01-HELED12-12VBTL	Aluminum Floodlight, hood extension	12w, 3000K 12v LED Panel	2.0 lbs.
CS-LFL-01-LED24-12VBTL	Aluminum Floodlight	2x 12w, 3000K 12v LED Panel	2.0 lbs.
CS-LFL-01-HELED24-12VBTL	Aluminum Floodlight, hood extension	2x 12w, 3000K 12v LED Panel	2.0 lbs.

### Beam/Glare Control Accessories

-HE

Add to catalog number for Hood Extension

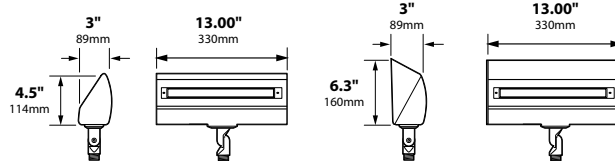

**CS-LFL-01-LED12**

**CS-LFL-01-HELED12**

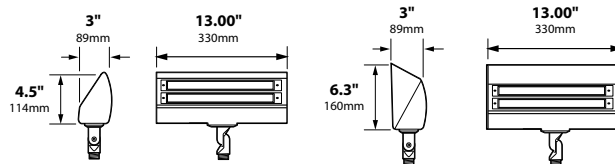

**CS-LFL-01-LED24**

**CS-LFL-01-HELED24**

### Lamp Color Options

Black Texture (Standard)	Antique Verde	Bronze Texture	Camel	White Texture	Hunter Texture	Rust	Weathered Iron	Weathered Brown	Stucco	Rubbed Verde	Chrome Powder	Acid Rust	Acid Verde	Black Acid Treatment
-BLT	-ATV	-BRT	-CAM	-WTX	-HTX	-RST	-WIR	-WBR	-STU	-RBV	-CPR	-BAR/CAR	-BAV/CAV	-BAT

BRASS & COPPER ONLY



### JOB INFORMATION

Type:	Date:
Job Name:	
Cat. No.:	
Lamp(s):	
Specifier:	
Contractor:	
Notes:	



**AMERICAN COMBAT VETERAN OWNED COMPANY**



405-673-8684

[www.gridshiftsolar.lighting](http://www.gridshiftsolar.lighting)





# Cuesta Sol™

## TORRENT SOLAR 12V PRO SOLAR SIGN LIGHT

### CS-PRE-TOR-(20W-40W)

### Lamp Mounting Accessories

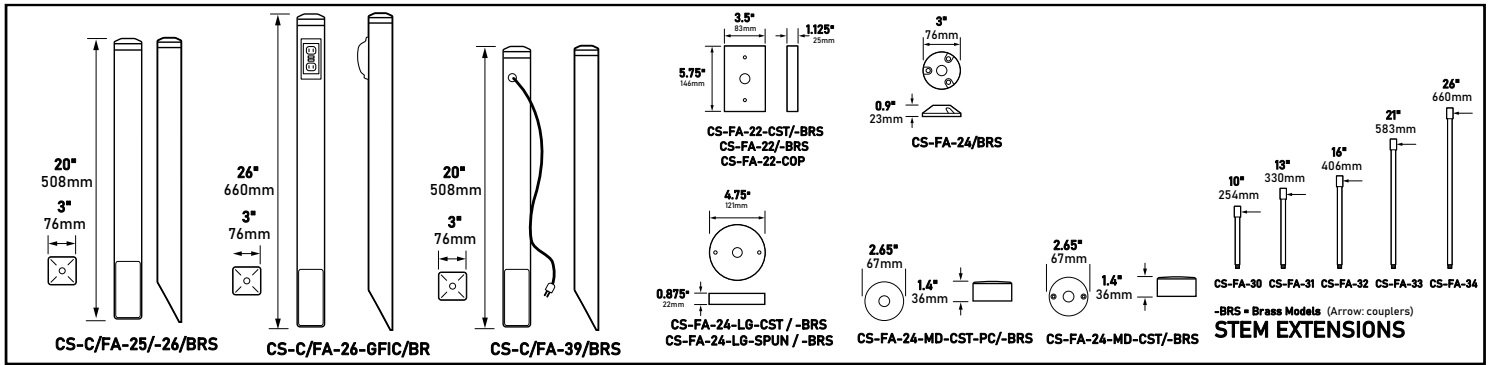

### Distributions & Photometrics

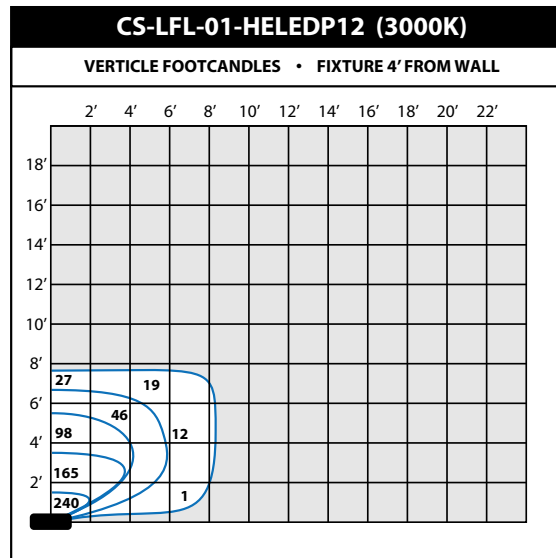
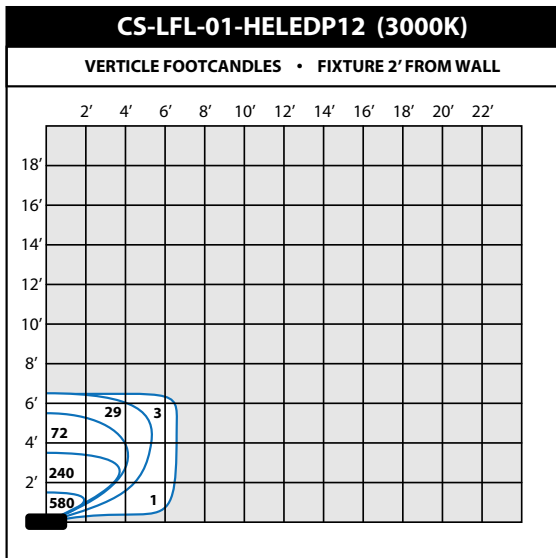
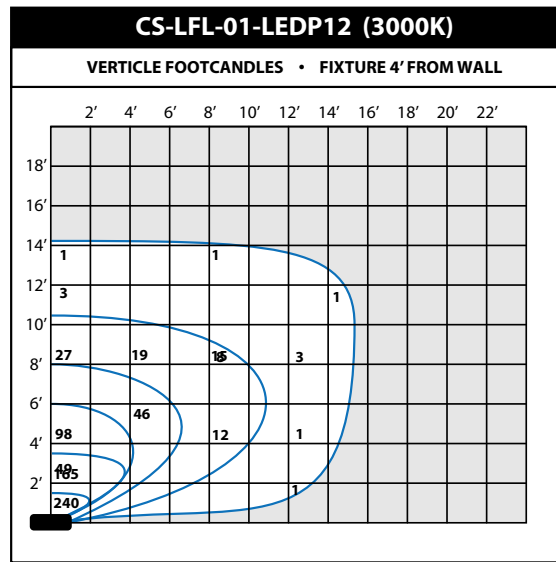
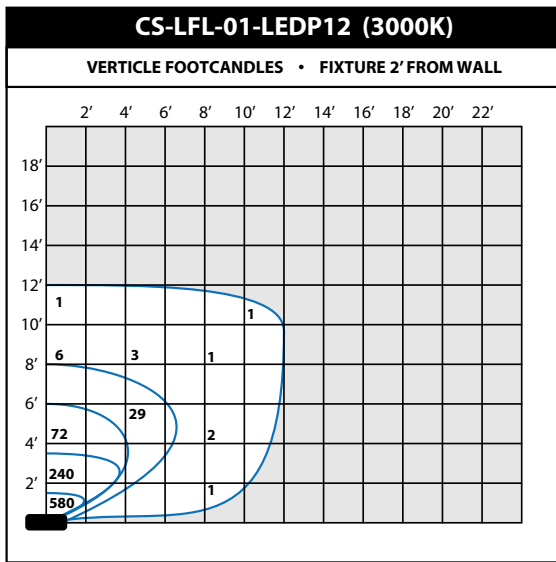

AMERICAN COMBAT VETERAN OWNED COMPANY



405-673-8684

[www.gridshiftsolar.lighting](http://www.gridshiftsolar.lighting)

**GRIDSHIFT™**  
SOLAR LIGHTING

Corporate: 2803 Broadway Ct. Edmond, OK 73013  
California: 1341 Distribution Way, Suite 20, Vista, CA 92081

Cuesta Sol is a trademark of GridShift Solutions, LLP



Wounded Warrior Project



Cuesta Sol™

TORRENT SOLAR 12V PRO SOLAR SIGN LIGHT

CS-PRE-TOR-(20W-40W)

Distributions & Photometrics

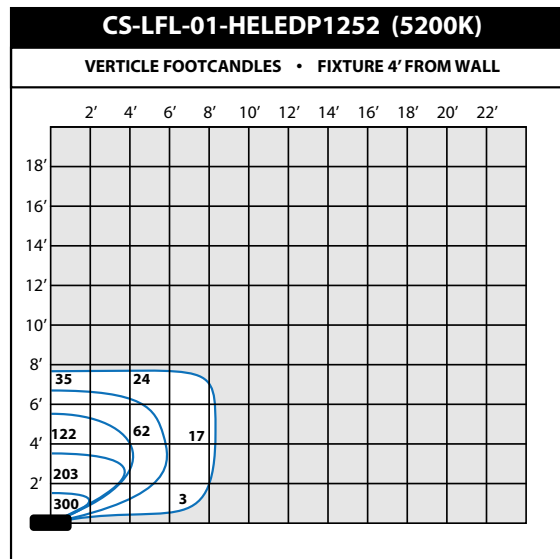
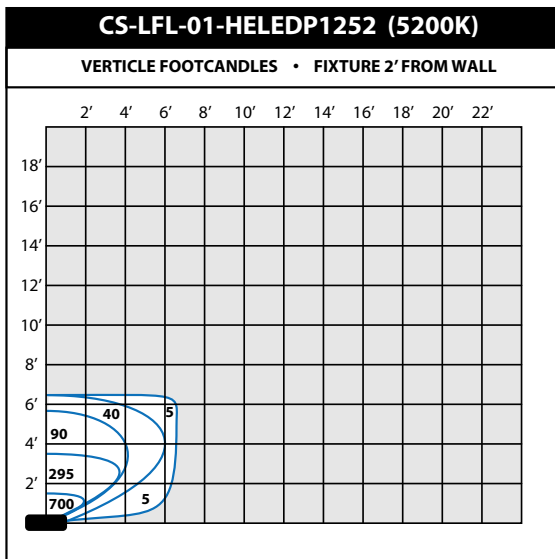
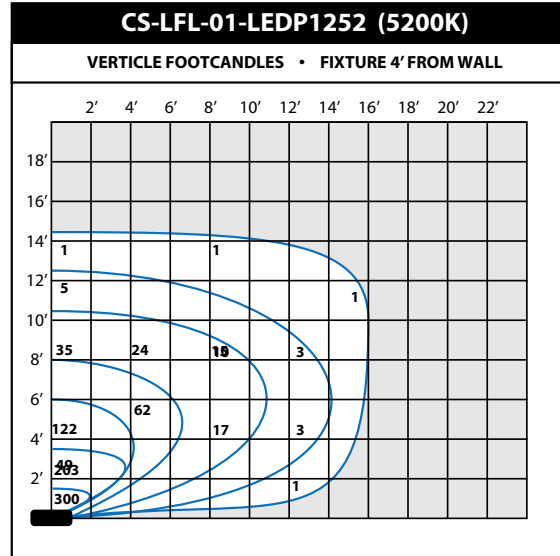
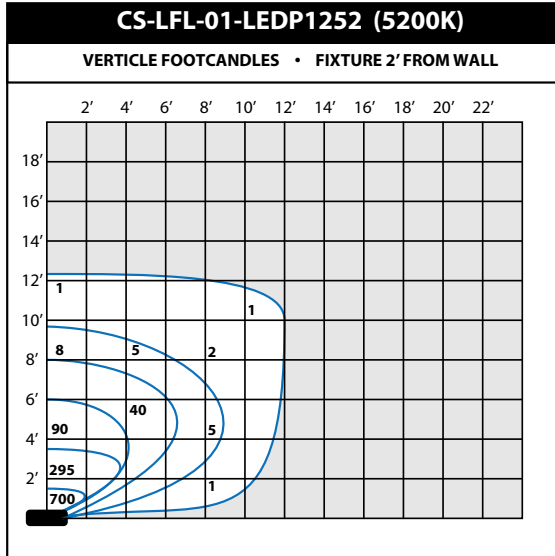

AMERICAN COMBAT VETERAN OWNED COMPANY



405-673-8684

[www.gridshiftsolar.lighting](http://www.gridshiftsolar.lighting)

**GRIDSHIFT™**  
SOLAR LIGHTING

Corporate: 2803 Broadway Ct. Edmond, OK 73013  
California: 1341 Distribution Way, Suite 20, Vista, CA 92081

Cuesta Sol is a trademark of GridShift Solutions, LLP



Wounded Warrior Project

Additional Sign Lighting Options



Internal, backlit and custom sign lighting options and configurations available. Please consult factory for full list of options and details.



AMERICAN COMBAT VETERAN OWNED COMPANY



405-673-8684  
[www.gridshiftsolar.lighting](http://www.gridshiftsolar.lighting)

