

**General**

- Low profile design
- Photocell sensor
- Deep cycle battery will charge and discharge over 2000 times
- Up to 177lm/w
- 8 Hour charge time from fully depleted battery
- 3000K-6500K CCT
- Wildlife/Turtle friendly amber CCT available



Exclusive Free  
Battery Recycling  
Program



**Certifications**



Available with:



5G Remote Access

- Monitor
- Set Timing
- Get Alerts
- Dimming

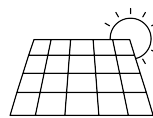

Monocrystalline  
Solar Module

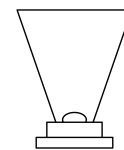

Philips Lumileds  
Luxeon 5050 Chips



IP65



Bluetooth  
Programming  
(optional)



**AMERICAN COMBAT VETERAN OWNED COMPANY**



405-673-8684

[www.gridshiftsolar.lighting](http://www.gridshiftsolar.lighting)

Corporate: 2803 Broadway Ct. Edmond, OK 73013  
 California: 1341 Distribution Way, Suite 20, Vista, CA 92081

Cuesta Sol is a trademark of GridShift Solutions, LLP

**GRIDSHIFT™**  
SOLAR LIGHTING



Wounded Warrior Project

### Construction

- Solar assembly construction marine grade aluminum and stainless steel
- UV stabilized polyester powder coat finish over primer for durability and corrosion resistance
- Streamlined design to reduce wind resistance
- All key components located beneath solar panel. Providing protection and easy access for maintenance
- Assembly comes pre-drilled and tapped for ease of installation
- Integral monocrystalline silicon solar panel
- 25 Year Lifespan
- Conversion rate up to 30%



### Solar Panel

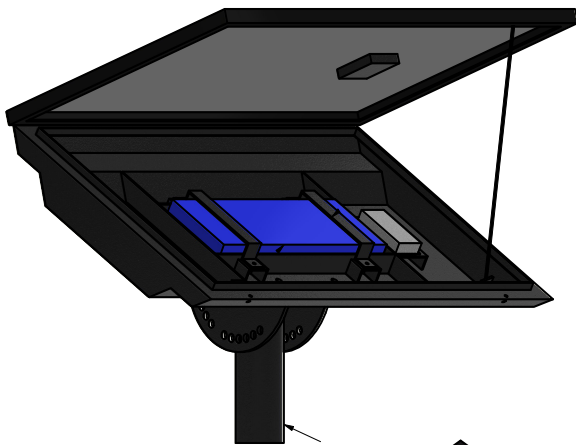

3.5" X 6" Pole top tenon required for solar panel installation

\*Custom Slip fitters available upon request

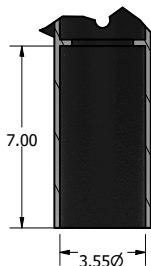

AMERICAN COMBAT VETERAN OWNED COMPANY



405-673-8684  
[www.gridshiftsolar.lighting](http://www.gridshiftsolar.lighting)

**GRIDSHIFT™**  
 SOLAR LIGHTING

Corporate: 2803 Broadway Ct. Edmond, OK 73013  
 California: 1341 Distribution Way, Suite 20, Vista, CA 92081

Cuesta Sol is a trademark of GridShift Solutions, LLP



Wounded Warrior Project

### Photometry

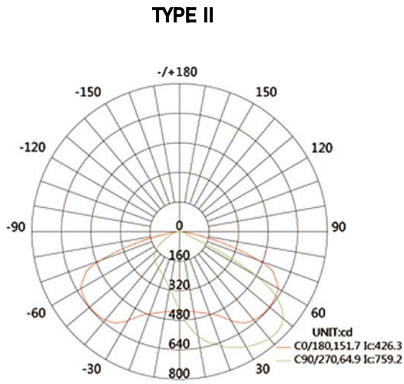

Average Beam Angle (50%): 108.3° Unit:cd

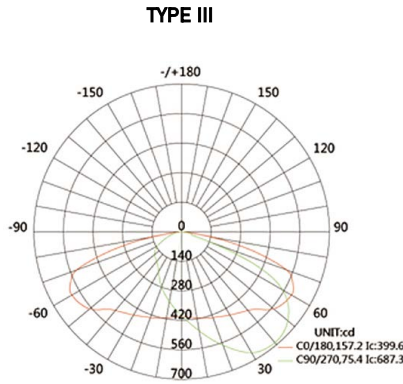

Average Beam Angle (50%): 116.3° Unit:cd

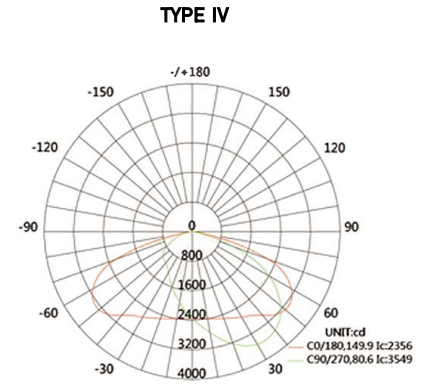

Average Beam Angle (50%): 115.3° Unit:cd

	CS-PRE-20W	CS-PRE-40W	CS-PRE-60W	CS-PRE-100W
<b>Wattage</b>	20W	40W	60W	100W
<b>LED Chip</b>	5050	5050	5050	5050
<b>Lumen Output</b>	3540lm	6680lm	10080lm	16800lm
<b>Efficacy</b>	177lm/w	167lm/w	168lm/w	168lm/w
<b>Weight</b>	42lbs	45lbs	45lbs	101lbs
<b>EPA</b>	4.2	5.5	9	12.5
<b>Optional Beam Angle</b>	T2/T3/T4			
<b>Input Voltage</b>	12-24V DC			
<b>Photovoltaic Panel</b>	Double Crystal Photovoltaic Panel			
<b>Solar Panel</b>	18V/70W	18V/130W	36V/200W	36V/280W
<b>Lithium-Ion Battery</b>	691.2WH 12.8V 54AH	1382.4WH 12.8V 102AH	2150.4WH 25.6V 84AH	2611.2WH 25.6V 102AH
<b>Discharge Time (Full Charge)</b>	30 Hours			
<b>Installation Height</b>	10-13ft	16-19ft	22-26ft	36-39ft
<b>Working Temperature</b>	14°F to 122°F			
<b>Charging Temperature</b>	32°F to 113°F			
<b>Control System</b>	MPPT Intelligent Controller			
<b>Autonomy</b>	30%-100% 102hrs (Max) 20%-80% 155hrs (Max)			
<b>Constant Mode (Full Charge)</b>	100% 30hrs 40% 78hrs			
<b>Wildlife &amp; Turtle Friendly CCT</b>	5050 LED Chips, 1900K CCT, 1.8% blue light content, 400-500 nanometer range of the visible light spectrum			



**AMERICAN COMBAT VETERAN OWNED COMPANY**



405-673-8684  
[www.gridshiftsolar.lighting](http://www.gridshiftsolar.lighting)





**CS-PRE-(20W-40W-60W-100W)-S**



**CS-PRE-(20W-40W-60W-100W)-D**

Model #	Watts	Voltage	00-No Motion SN-Motion Sensor	Color Temp in 100K	CRI	Available Optic Types	Optional 5G Remote Access (Yes/No)	S - Single D - Double
Cuesta Sol CS-PRE	20	NV-12 DC	00 / SN	19K / 30K / 40K / 50K / 57K / 65K	70 CRI / 80 CRI	II / III / IV	Y / N	S / D
Cuesta Sol CS-PRE	40	NV-12 DC	00 / SN	19K / 30K / 40K / 50K / 57K / 65K	70 CRI / 80 CRI	II / III / IV	Y / N	S / D
Cuesta Sol CS-PRE	60	NV-24V DC	00 / SN	19K / 30K / 40K / 50K / 57K / 65K	70 CRI / 80 CRI	II / III / IV	Y / N	S / D
Cuesta Sol CS-PRE	100	NV-24V DC	00 / SN	19K / 30K / 40K / 50K / 57K / 65K	70 CRI / 80 CRI	II / III / IV	Y / N	S / D

Ordering Description Example								
Cuesta Sol CS-PRE	60	NV-24V DC	SN	50	80	IV	Y	S

Ordering Description								
Cuesta Sol CS-PRE	20	NV-12 DC						
Cuesta Sol CS-PRE	40	NV-12 DC						
Cuesta Sol CS-PRE	60	NV-24V DC						
Cuesta Sol CS-PRE	100	NV-24V DC						



**AMERICAN COMBAT VETERAN OWNED COMPANY**



405-673-8684  
[www.gridshiftsolar.lighting](http://www.gridshiftsolar.lighting)

