

### 9μτγ αοö ΖμÜμΆö

€ n ï μδδδμρ ÇUαÇÄ nάÖyάÜö

- ΖδΑÇμρöZ ý ÿ
- ! , j u9A & Ζ δÜ uÉ μ γμδδδÜ ΤΜρ μ
- NάÜμρöÇμ
- nÜ ΤΜρ! αÜyαÇüö



Exclusive Free  
Battery Recycling  
Program

€ nÜ ΤΜρμρ ÇUαÇÄ Zi yάÜΤÖ

- yάÜ ΤΜρ NÉÇy uÉ μ! αÜyαÇü
- AÜδΤμ ? Ü ΤΜρ nμÜδδδ gA
- S É çä ΤΜρ nμÜδδδ
- S μ ΤΜρ μρ αÜyαÇüÜ αÜyαÇüÄ ΤΜρ ΤΜρ Çμ

Available with:



5G Remote Access

- Monitor
- Set Timing
- Get Alerts

26.75 (40W)  
19.50 (20W)

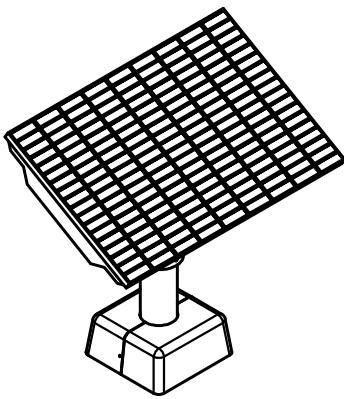
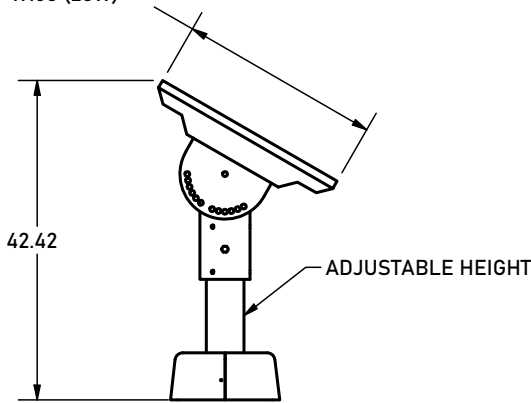

OTHER MOUNTING OPTIONS  
AVAILABLE SUCH AS  
RETROFITTING  
ON EXISTING POLES.

CUSTOM CAGES  
AVAILABLE FOR SHORT  
POLE MOUNT  
INSTALLATIONS



### Certifications



41.13 40W  
32.25 20W

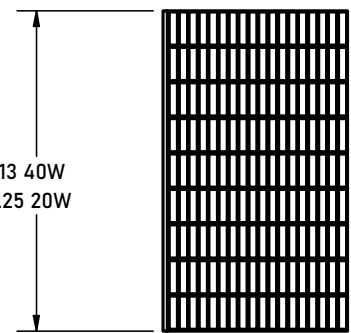

Model	Watts	Solar Panel	Battery
Cuesta Sol CS-PRE-FOX	20W	18V/70W	691.2WH / 12.8V / 54AH
Cuesta Sol CS-PRE-FOX	40W	18V/130W	1382.4 WH / 12.8V / 102AH



AMERICAN COMBAT VETERAN OWNED COMPANY



405-673-8684  
[www.gridshiftsolar.lighting](http://www.gridshiftsolar.lighting)



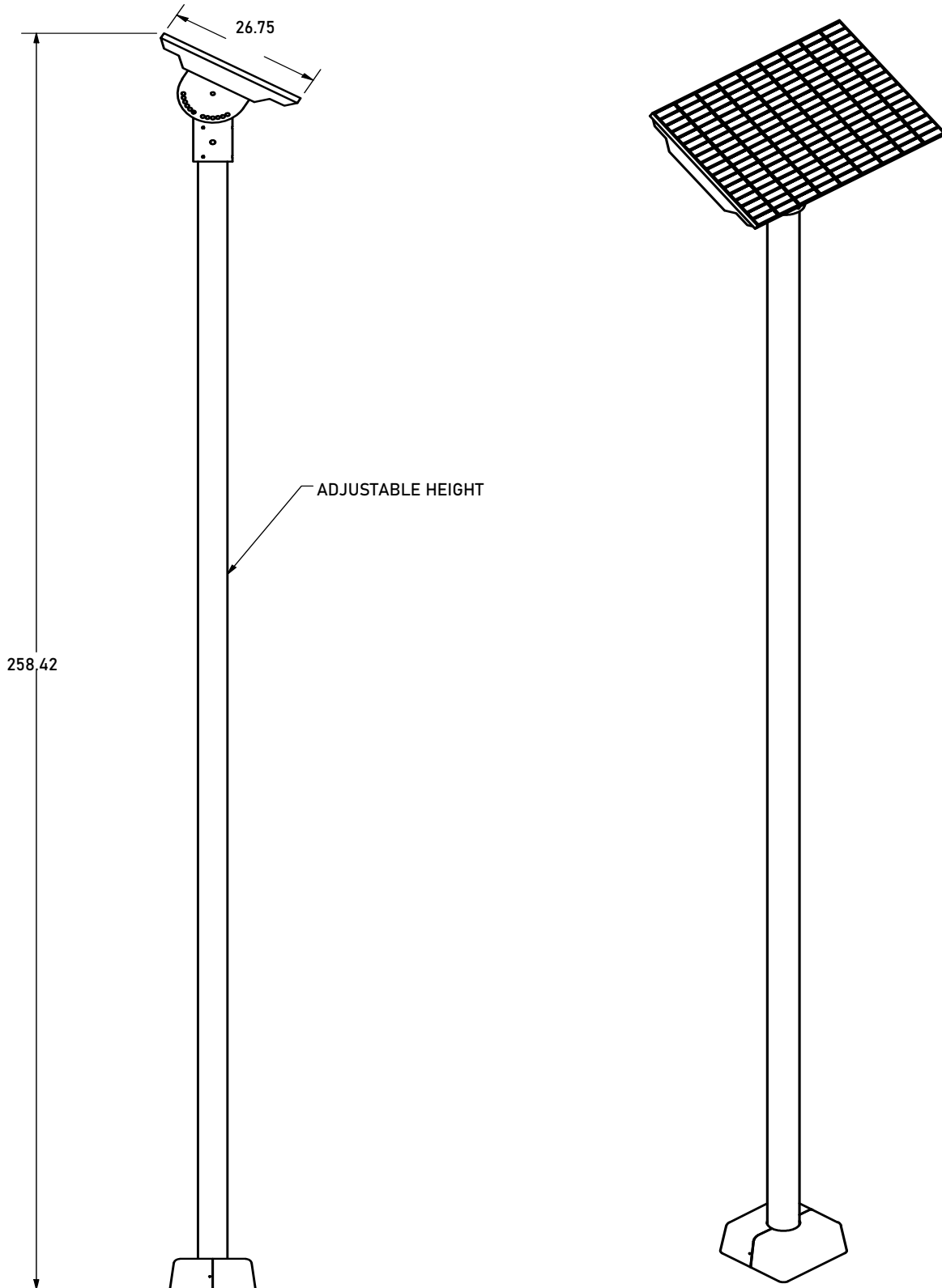

AMERICAN COMBAT VETERAN OWNED COMPANY



405-673-8684  
[www.gridshiftsolar.lighting](http://www.gridshiftsolar.lighting)



### Specifications & Ordering Information

**CONSTRUCTION:**

**BODY:** Fiberglass reinforced bronze composite with molded brass inserts for screws  
**LENS HOLDER & GRATE:** Fiberglass reinforced bronze composite, cast aluminum or cast brass  
**AIMING CAPABILITY:** 30°

**LENS:** High impact clear tempered convex glass

**LAMP OPTIONS:** MR16, PAR36, LED Module

**SOCKET:** MR16: High temperature ceramic GU5.3 bi-pin with 250°C silicone lead wires PAR36:

None, PAR36 lamp supplies connection via 1/4" quick connect or stud terminal

**REFLECTOR:** Highly polished specular aluminum

**WIRING:** Black 4 foot 18/2 zip cord from base of fixture

For 25 foot 16/2 fixture lead wire add -25F to catalog number.

**CONNECTION:** FA-05 Quick Connector (not supplied) from fixture to main cable (12/2, 10/2 or 8/2 only)

**FINISH:** Composite - Bronze

Aluminum Lens Holder/Grate - Black texture polyester powder coat. Optional finishes available

Brass Lens Holder/Grate - Unfinished brass. Optional finishes available

**120v INTEGRAL TRANSFORMER MODELS AVAILABLE, ADD -T TO CATALOG NUMBER FEATURES**

**120v INPUT, 12v OUTPUT/75w MAX, DIMMABLE (LINE SIDE)**

**NOT FOR USE WITH LED LAMPS**

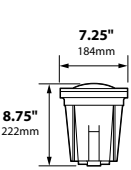

Shown with Lens only

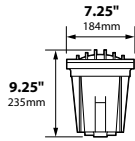

Shown with Grate

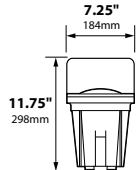

Shown with Light shield



**BOTTOM**

2 Female 3/4" NPS & 3 Female 1/2" NPS threaded ports available



**LED MODULE OPTICS:**

Distribution	Angle
Spot	15°
Narrow Flood	40°
Wall Wash	60°
Wide Flood	160°

### Certifications



AMERICAN COMBAT VETERAN OWNED COMPANY



405-673-8684

[www.gridshiftsolar.lighting](http://www.gridshiftsolar.lighting)



Ordering Description Example												
CS-FOX-12VP	45W	2	M75	T10	B	BLT	MOD	7W	3K	WW	RA-LS	PM-3-15

Ordering Description												
CS-FOX-12VP												

Model#	Wattage	Qty Well Light	Main Cable Length FT	T Cable Length Ea	Lens Ring Material	Lens Ring Color	Light Source	Wattage	Color Temp	Distribution	Accessories	Mounting Options
CS-FOX-12VP	30W	(1) Well Light	M25	T10	(C) Composite	(BLT) Black Textured (STD.)	(M16) LED MR-16	(MOD) 7W	(3K) 3000K	(SP) Spot	(RA) Rebar Anchor	(GS) Ground Stake
	45W	(2) Well Lights	M35	T20	(A) Aluminum	(ATV) Antique Verde	(P36) LED PAR36	(MOD) 11W	(4K) 4000K	(NF) Narrow Flood	(LS) Light Shield	(PM) Pole Mount Specify Pole Diameter & Height
	Custom Consult Factory		M50	Other Specify Ft	(B) Brass	(BRT) Bronze Textured	(MOD) LED Module	(MOD) 15W	(5K) 5000K	(WW) Wall Wash	(AG) Aluminum Grate	Custom Consult Factory
			M75			(WTX) White Textured		(MOD) 20W		(WF) Wide Flood	(BG) Brass Grate	
			M100			(WTR) Weathered Iron		(M16) Specify Wattage			(ML) Mini Louver	
			Other Specify Ft			(CPR) Chrome Powder		(P36) Specify Wattage			(CF) Concrete Form	
						(CUS) Custom Powder					(STG) Stepped Tempered Glass Lens	
											(ATG) Amber Tempered Glass Lens	
											(BTG) Blue Tempered Glass Lens	
											(RTG) Red Tempered Glass Lens	

### Light Distributions and Photometrics (Shown for modules only)

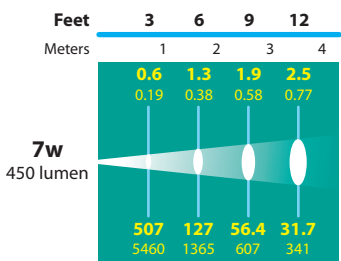

15° SPOT

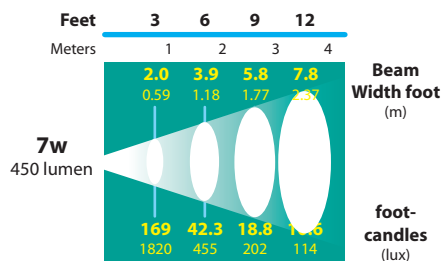

40° NARROW FLOOD

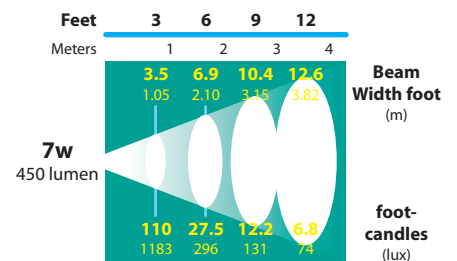

60° WALL WASH



AMERICAN COMBAT VETERAN OWNED COMPANY



405-673-8684  
[www.gridshiftsolar.lighting](http://www.gridshiftsolar.lighting)

